

G9SP

The G9SP safety controller provides all local safety based in- and outputs and controls the safety application.

- Three CPU-types to suit different applications
- Clear diagnosis and monitoring via Ethernet or Serial connection
- Memory cassette for easy duplication of configuration
- Unique programming software to support easy design, verification, standardization and reuse of the program.
- Certified according to PLe (EN ISO 13849-1) and SIL 3 (IEC 61508)

Ordering information

Appearance	Appearance description	Order code
Standalone Safety Controller	10 PNP safety inputs 4 PNP safety outputs 4 test outputs 4 PNP standard outputs	G9SP-N10S
	10 PNP safety inputs 16 PNP safety outputs 6 test outputs	G9SP-N10D
	20 PNP safety inputs 8 PNP safety outputs 6 test outputs	G9SP-N20S

Software

Appearance	Media	Applicable OS	Order code
G9SP configurator	Setup disk 1 license	Windows 2000	WS02-G9SP01-V1
	Setup disk 10 licenses	Windows XP	WS02-G9SP10-V1
	Setup disk 50 licenses	Windows Vista	WS02-G9SP50-V1
	Setup disk Site license		WS02-G9SPXX-V1

Expansion units (standard I/O)

Appearance	Type	Number of I/O		Model
		In	Out	
Expansion I/O unit	Sinking	12	8 (solid state)	CP1W-20EDT
	Sourcing	12	8 (solid state)	CP1W-20EDT1
	Sinking	-	32 (solid state)	CP1W-32ET
	Sourcing	-	32 (solid state)	CP1W-32ET1
I/O Connecting cable, 80 cm long				CP1W-CN811

Option units

Appearance	Order code
RS-232 Option Board	CP1W-CIF01
Ethernet Option Board (Ver. 2.0 or later)	CP1W-CIF41
Memory Cassette	CP1W-ME05M

G9SP configuration

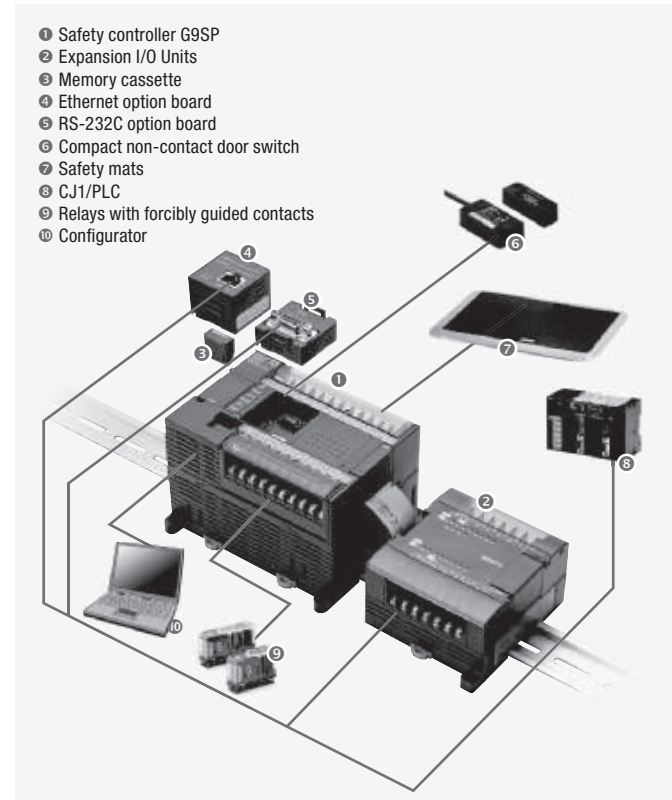

Specifications

General specifications

Power supply voltage		20.4 to 26.4 VDC (24 VDC -15% +10%)
Consumption current	G9SP-N10S	400 mA (V1: 300 mA, V2: 100 mA)
	G9SP-N10D	500 mA (V1: 300 mA, V2: 200 mA)
	G9SP-N20S	500 mA (V1: 400 mA, V2: 100 mA)
Mounting method		35-mm DIN track
Ambient operating temperature		0°C +55°C
Ambient storage temperature		-20°C +75°C
Degree of protection		IP20 (IEC 60529)

Safety input specifications

Input type	Sinking inputs (PNP)
ON voltage	11 VDC min. between each input terminal and G1
OFF voltage	5 VDC max. between each input terminal and G1
OFF current	1 mA max.
Input current	6 mA

Safety output specifications

Output type	Sourcing outputs (PNP)
Rated output current	0.8 A max. per output*
Residual voltage	1.2 V max. between each output terminal and V2
Test output specifications	
Output type	Sourcing outputs (PNP)
Rated output current	0.3 A max. per output*
Residual voltage	1.2 V max. between each output terminal and V1
Standard output specifications (G9SP-N10S)	
Output type	Sourcing outputs (PNP)
ON Residual voltage	1.5 V max. (between each output terminal and V2)
Rated output current	100 mA max.*

*For details on the rated output current, please refer to the user manual of G9SP.

Control system integration

Safety - I/O-status becomes transparent

The standalone Safety Controller offers diagnosis information in 3 ways:

- 1) via parallel wiring
- 2) via serial RS232C interface (option)
- 3) via Ethernet interface (option).

Information of all safety in- and outputs on the standard control system ensure minimum downtime of the machine.

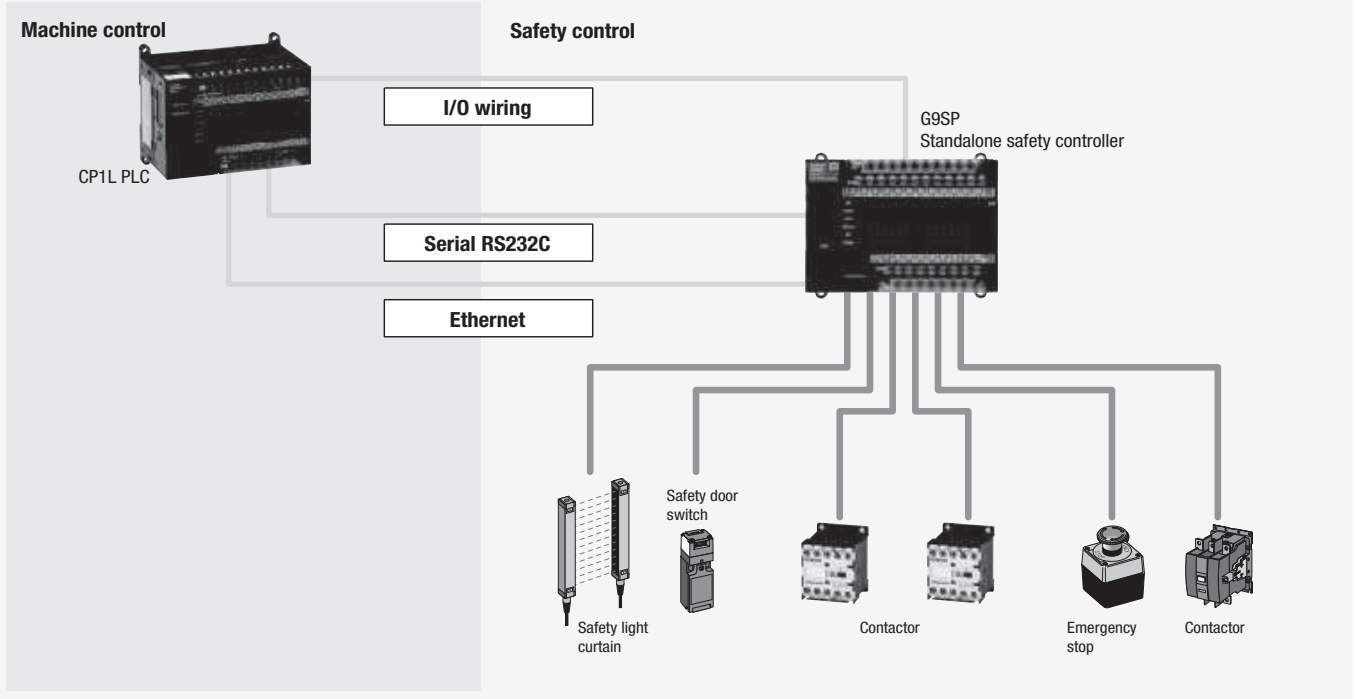

G9SP configuration tool

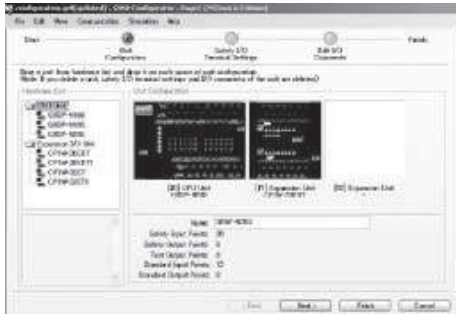

Easy setup and configuration is provided by a setup wizard supporting the hardware selection.

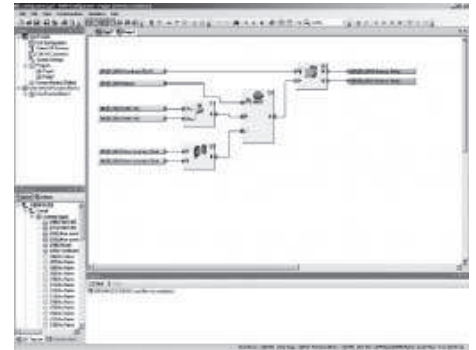

User-defined function blocks

Approved configuration elements such as a tested door monitoring solution can be easily stored as a user defined function block and re-used in future projects. This minimises the time it takes to create a new system configuration.

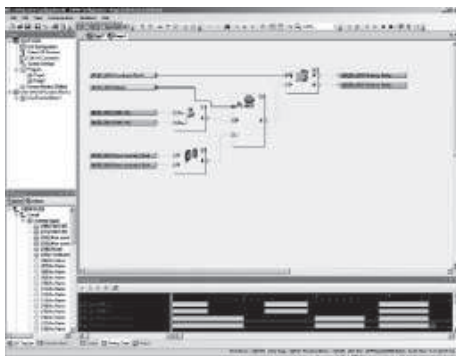

Integrated Simulator

All functions can be tested and simulated in the Configuration Tool, so there's no unnecessary additional workload for the engineer. In addition, on-line diagnosis reduces debug time to a minimum during implementation in the machine control system.

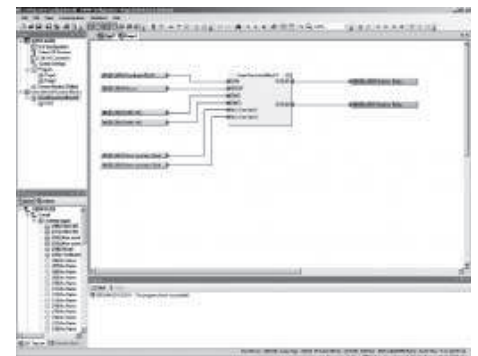











Knowledge-building

Existing configurations are the basis for new projects. The G9SP Configuration Tool supports re-use of existing and proven know-how in safety control, as well as user-defined function blocks. Which means no more repetition of effort, instead a growing library of safety solutions.







Functions

Function Blocks













Logic Functions

Function Block Name	Notation on Function List	Icon
NOT	NOT	
AND	AND	
OR	OR	
NAND	NAND	
NOR	NOR	
Exclusive OR	EXOR	
Exclusive NOR	EXNOR	
RS-FF (Reset Set/Flip-Flop)	RS-FF	
Comparator	Comparator	
Comparator 2	Comparator2	



Timer/Counter Functions

Function Block Name	Notation on Function List	Icon
Off-Delay Timer	Off-Delay Timer	
On-Delay Timer	On-Delay Timer	
Pulse Generator	Pulse Generator	
Counter	Counter	
Up-Down Counter	Up-Down Counter	
Serial-Parallel Converter	Serial-Parallel Converter	



Safety Device Function Blocks

Function Block Name	Notation on Function List	Icon
External Device Monitoring	EDM	
Enable Switch Monitoring	Enable Switch	 Enable
Emergency Stop Switch Monitoring	E-Stop	
Light Curtain Monitoring	Light Curtain Monitoring	
Muting	Muting	 Mute
Safety Gate Monitoring	Safety Gate Monitoring	
Two Hand Controller	Two Hand Controller	
User Mode Switch Monitoring	User Mode Switch	
Redundant Input Monitoring	Redundant Input	
Single Beam Safety Sensor	Single Beam Safety Sensor	
Non-Contact Door Switch Monitoring	Non-Contact Door Switch	
Safety Mat Monitoring	Safety Mat	

Reset and Restart Function Blocks

Function Block Name	Notation on Function List	Icon
Reset	Reset	 RESET
Restart	Restart	 Restart

Connector Function Blocks

Function Block Name	Notation on Function List	Icon
Multi Connector	Multi Connector	
Routing	Routing	

Dimensions

Safety Controller G9SP-N10S

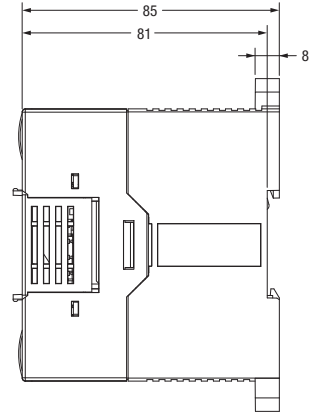
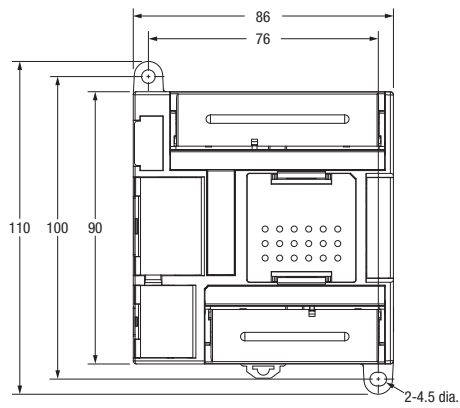

G9SP-N10D/G9SP-N20S

