

High-Coded Guard Lock Safety Door Switch D41L

Keep your machines hygienic

- High-coded safety door switch effective in tamper protection
- Hygienically designed switch
 - Unique locking mechanism prevents water and foreign matter from collecting
 - Smooth surface leaves no wiping unevenness
- Complies with EN ISO 14119 (Type 4/High Coded), EN ISO 13849-1 (PLe)
- ECOLAB certified



* The actuator is sold separately.

 Refer to *Safety Precautions* on page 18

For the most recent information on models that have been certified for safety standards, refer to your OMRON website.

Features

The D41L is a high-coded safety door switch in which the combination of the switch and actuator is fixed by pairing with more than 1,000 variations available. You can develop applications requiring door lock while minimizing defeat possibilities.

Identical mounting for left and right hinged doors



Large actuator tolerances

- Actuator tolerance in longitudinal direction ± 3.5 mm, lateral direction ± 2.0 mm



Easy latching force adjustment

- The latching force can be increased from 25 N to 50 N simply by turning the star handle 180°.
- Position I: approx. 25 N, Position II: approx. 50 N



LED display

- Smart diagnostic by means of 3-color LED's
- LED red: Fault
- LED yellow: Status
- LED green: Power

D41L

Model Number Structure

Model Number Legend

Safety Door Switch Switch

D41L - □ □ D □ □ - N2
(1) (2) (3) (4) (5) (6) (7)

(1) Model

L: Guard Lock

(2) Coding level / Teaching limitation

1: High (Individual coding) / Teaching is not-repeatable
2: High (Individual coding) / Teaching is repeatable

(3) OSSD configuration

Y: Guard monitoring AND lock monitoring
Z: Only guard monitoring

(4) Diagnosis output

D: With diagnosis output (Auxiliary output)

(5) Lock and release

A: Power to unlock (Mechanical lock / Solenoid release)
G: Power to lock (Solenoid lock / Mechanical release)

(6) Release type

Blank: Manual release
E: Emergency exit

(7) Connection method

N2: M12 Connector

Actuator

D41L - A 1
(1) (2)

(1) Model

L: Guard Lock





(2) Actuator type

A1: Standard

Ordering Information

List of Models

Switch

Classification (Lock and Release)	Appearance	Coding level / Teaching limitation	OSSD configuration	Emergency exit	Model	
Power to unlock (Mechanical lock / Solenoid release)		High / Teaching is not-repeatable	Only guard monitoring	-	D41L-1ZDA-N2	
		High / Teaching is repeatable	Only guard monitoring	-	D41L-2ZDA-N2	
		High / Teaching is not-repeatable	Guard monitoring AND lock monitoring	-	D41L-1YDA-N2	
		High / Teaching is repeatable	Guard monitoring AND lock monitoring	-	D41L-2YDA-N2	
		High / Teaching is repeatable	Guard monitoring AND lock monitoring	Emergency exit	D41L-2YDAE-N2	
	Power to lock (Solenoid lock / Mechanical release)		High / Teaching is not-repeatable	Only guard monitoring	-	D41L-1ZDG-N2
			High / Teaching is repeatable	Only guard monitoring	-	D41L-2ZDG-N2
			High / Teaching is not-repeatable	Guard monitoring AND lock monitoring	-	D41L-1YDG-N2
High / Teaching is repeatable			Guard monitoring AND lock monitoring	-	D41L-2YDG-N2	
		High / Teaching is repeatable	Only guard monitoring	Emergency exit	D41L-2ZDGE-N2	

Actuator (Sold separately)



Appearance	Name	Features	Model
	Actuator	3 different directions of actuation	D41L-A1

Accessory (Sold separately)

Connecting cables

Appearance	Name	Specifications	Cable length	Model
	Connecting cables with M12 Connector	Connecting cables with M12 Connector (female), 8-pole – 8 x 0.25mm ² , straight, IP69	5 m	D41L-8P5-CFM12-905M
			10 m	D41L-8P5-CFM12-910M

Mounting

Appearance	Name	Application	Model
	Mounting plate	For Switch	D41L-MP
	Mounting set	For Actuator	D41L-MS

D41L

Standards Certification

Directives

- Machinery Directive
- RE Directive
- RoHS Directive
- WEEE Directive



Dispose in accordance with applicable regulations.

Standards

- EN ISO 13849-1: PL e Category 4
- EN 60947-5-3
- IEC 61508
- EN 300 330
- EN ISO 14119

UL Certification

- UL508
- CAN/CSA C22.2 No.14

Regions where D41L can be used

The product can be used in Japan, the United States, Canada, EU member states, the United Kingdom, China, Australia, and New Zealand. The use in other countries may conflict with radio laws of the countries.

Ratings and Specifications

Model		D41L
Technical		
Detection method	RFID	
Frequency band	125 kHz	
Transmitter output	-6 dBm max.	
Interlock type (ISO 14119)	Type 4	
Coded level (ISO 14119)	High	
Actuator	D41L-A1	
Response time (ON to OFF)	100 ms max.	
Response time (input)	1.5 ms max.	
Risk time	200 ms max.	
Startup time after power ON	5 s max.	
Typical operating distance (Sn)	2 mm	
Assured operating distance (OFF to ON) (assured operating distance, Sao) (IEC 60947-5-3)	1 mm	
Assured switch-off distance (ON to OFF) (assured release distance, Sar) (IEC 60947-5-3)	20 mm	
Electrical		
Supply voltage (Ue)	24 VDC (-15%/+10%) (stabilized PELV-power supply)	
Current consumption (Io)	< 0.1 A	
Overvoltage category	III	
Pollution degree	3	
Operating current device with magnet switched on	Average: <0.2 A Peak: 0.35 A/200 ms	
Magnet switch on time (ED)	100%	
Conditional short-circuit current	100 A	
External device fuse rating	2 A(T)	
Safety input	Switching thresholds	-3 V to 5 V (low) 15 V to 30 V (high)
	Current consumption per input	5 mA / 24 V max.
	Accepted test pulse duration	1.0 ms max.
	Test pulse interval	≥100 ms
Safety output (OSSD)	Switching element	PNP type, short-circuit proof
	Utilization category	DC-12: 24 VDC (Ue)/0.25 A (Ie) DC-13: 24 VDC (Ue)/0.25 A (Ie)
	Rated operating current (Ie)	0.25 A
	OFF-state leakage current (Ir)	0.5 mA max.
	Voltage Drop (Ud)	4 V max.
	Short-circuit monitoring	Yes
	Test pulse duration	0.3 ms max.
Test pulse interval	1,000 ms	
Auxiliary output	Switching element	PNP type, short-circuit proof
	Utilization category	DC-12: 24 VDC (Ue)/0.05 A (Ie) DC-13: 24 VDC (Ue)/0.05 A (Ie)
	Rated operating current (Ie)	0.05 A
	Voltage drop (Ud)	4 V max.
Solenoid	Switching thresholds	-3 to 5 V (low) 15 to 30 V (high)
	Power consumption	10 mA/24 V
	Magnet switching-on time	100%
	Accepted test pulse duration	5.0 ms max.
	Test pulse interval	40 ms min.

D41L

Model	D41L
Mechanical	
Protection class	III
Switching frequency	0.5 Hz max.
Rated insulation voltage (Ui)	32 VDC
Rated impulse withstand voltage (Uimp)	0.8 kV
Minimum operating current (Im)	0.5 mA
Fixing screws	2 × M6
Tightening torque of fixing screws	6 to 7 N·m
Latching force	25 N/50 N
Guard door weight	5 kg max.
Angular misalignment between safety door switch and actuator	2° max.
Holding force (Fzh) (min.)	1,150 N
Operating speed	0.5 m/s max.
Mechanical durability	1,000,000 operations min.
Mechanical durability (when used as door stop)	50,000 operations min.
Material	Fiberglass reinforced thermoplastic self-digestion (Enclosure)
Weight	Unit: <580 g, Package: <650 g
Environmental	
Ambient operating temperature	0 to 60 °C
Ambient storage temperature (including during transportation)	-10 to 90 °C
Ambient operating humidity	93% max. (non-condensing, non-icing)
Degree of protection (IEC 60529)	IP66, IP67 and IP69
Vibration resistance	10 to 150 Hz, amplitude 0.35 mm
Shock resistance	30 g/11 ms
Connection	
Series connection	31 max. *1
Cable lengths	70 m max. (between switch and power supply)
Connection	M12 connector, 8-pole

*1. Refer to *Connection* on page 10 for connection specifications with the Safety controller.

Safety classification information

Interlocking function	
Standard	ISO 13849-1, IEC 61508, IEC 62061
PL	e
DC	99%
Safety Category	4
PFH	5.2×10^{-10}
PFD	4.5×10^{-5}
SIL	Suitable for SIL3 applications
Mission time	20 years

Guard lock function	
Standard	ISO 13849-1, IEC 61508, IEC 62061
PL	d
DC	99%
Safety Category	2
PFH	2.0×10^{-9}
PFD	1.8×10^{-4}
SIL	Suitable for SIL2 applications
Mission time	20 years

- Note:**
1. The actuation of the interlock must be compared with the external OSSD enabler. If a shut-down now occurs due to an unintentional unlocking this is detected by an external diagnostic.
 2. The safety consideration of the guard locking function only applies for monitored safety door switch D41L-□Y.
 3. If for a certain application the power to unlock type of a safety door switch cannot be used, then for this exception the power-to-lock type of a safety door switch can be used if additional safety measure need to be realized that have an equivalent safety level.
 4. The safety analysis of the guard locking function refers to the component safety door switch as part of the complete system. In the event of a fault resulting in the unlocking of the guard locking, this is detected by the safety outputs (OSSD) Y1/Y2 of the safety door switch switch off. When such a fault occurs the protection equipment may open immediately, just once, before the safe condition of the machine is reached. The system reaction of category 2 allows that a fault can occur between tests causing the loss of the safety function which is detected by the test.
 5. If multiple safety door switches are involved in the same safety function, the PFH values of the individual components must be added.

UL

This device is intended to be powered by a Listed Limited Voltage, Limited Current or Class 2 source.

This device shall be powered with the use of a Listed (CYJV) cable/connector assembly rated 24 Vdc, 0,8 A minimum.

FCC

This device complies with part 15 of the FCC Rules and contains license-exempt transmitter(s)/receiver(s) that comply with Innovation, Science and Economic Development Canada's license-exempt RSS(s): Operation is subject to the following two conditions:

1. This device may not cause harmful interference, and
2. this device must accept any interference received, including interference that may cause undesired operation.

This device complies with the Nerve Stimulation Exposure Limits (ISED RSS-102) for direct touch operations. Changes or modifications not expressly approved by OMRON Corporation could void the user's authority to operate the equipment.

D41L

Structure and Nomenclature

Switch and Actuator

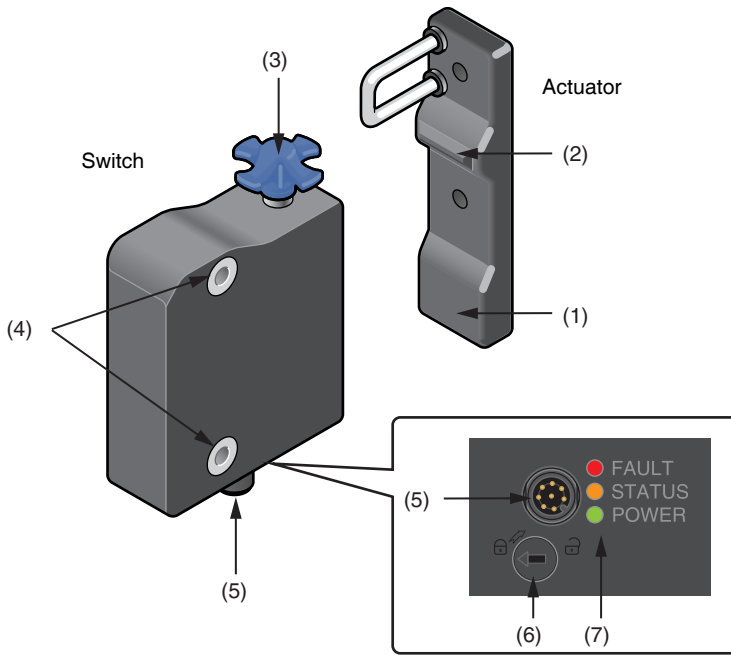

Emergency exit (D41L-□□D□E-N2)

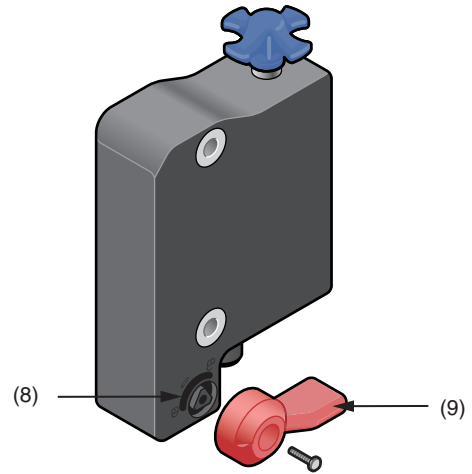

1. High degree of protection against defeating due to the coded RFID switch (also available with individual coding)
2. Dampener for door stop - saves costs: no additional mounting parts required
3. Star handle - adjustable latching force - 25 N or 50 N
4. Mounting hole for M6 screws
5. M12 connector, 8-pole
6. Manual release
7. LED display
8. Triangular (both sides) for installation of the emergency exit or the emergency release lever.
9. Lever for emergency exit or emergency release

Actuating Directions and Actuator Positions



Actuation from the side



Actuation from the rear side



Actuation from the front

Connection

Pin assignment

Function		Pin assignment	Color codes of the OMRON's connectors D41L-8P5-CFM12-9□□M
A1	U _e	1	WHITE
X1	Safety input 1	2	BROWN
A2	GND	3	GREEN
Y1	Safety output 1	4	YELLOW
OUT	Auxiliary output	5	GRAY
X2	Safety input 2	6	PINK
Y2	Safety output 2	7	BLUE
IN	Solenoid control	8	RED

Wiring Examples

The application examples shown are suggestions. They however do not release the user from carefully checking whether the safety door switch and its set-up are suitable for the individual application.

The power supply for the safety door switch must provide protection against permanent overvoltage. To that effect, stabilized PELV supply units must be used. The safety outputs (OSSD) can be directly connected in the safety circuit of the control system. For applications of PL e / safety category 4 in accordance with ISO 13849-1, the safety outputs (OSSD) of safety door switch or safety door switch of the chain must be connected to a safety controller or safety relay unit of the same Safety Category.

If the safety door switch is connected to the safety input of a safety controller or safety relay unit, the controller must have a dual-channel monitoring time of at least 100 ms and the accepted test pulse duration of at least 1 ms. Also, the cross-wire-short monitoring function must be disabled.

Wiring example to connect a safety controller

When connecting multiple safety door switches in series, apply 24 VDC to safety inputs X1 and X2 on the Nth unit, as shown in the figure below.

Connect safety outputs Y1 and Y2 to safety inputs X1 and X2 of the following safety door switch.

Connect safety outputs Y1 and Y2 of the first unit to the safety controller or safety relay unit.



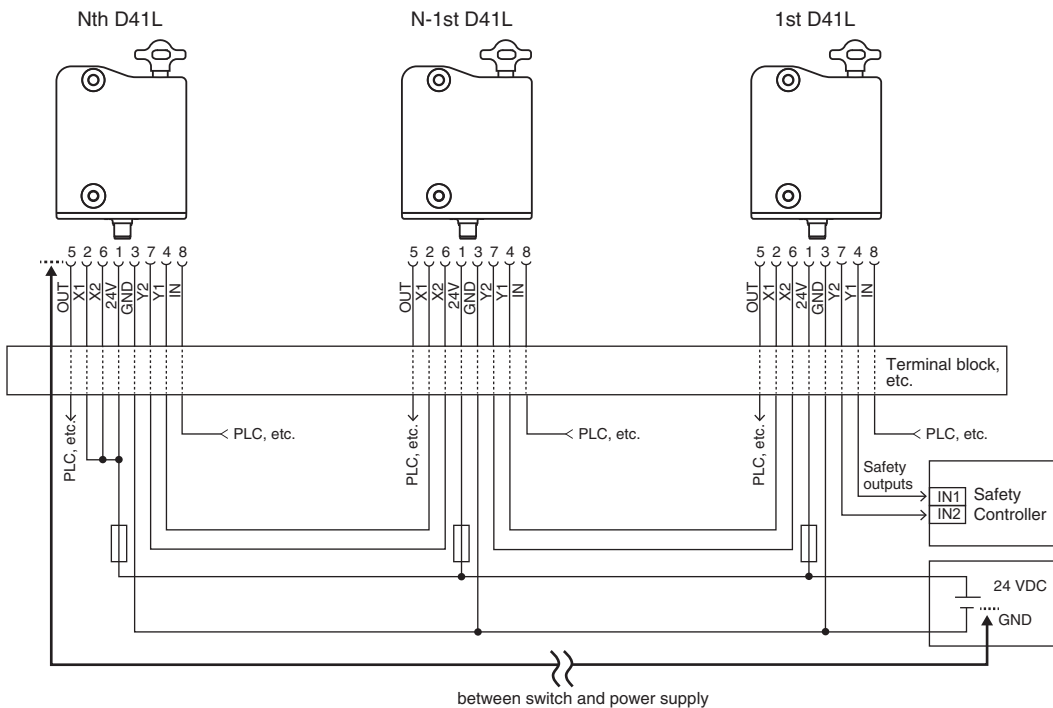

Connect the auxiliary output to the PLC, etc.

When connecting a single safety door switch to the safety controller or safety relay unit, apply 24 VDC to safety inputs X1 and X2 in the same manner as the Nth unit shown below, and then connect safety outputs Y1 and Y2 to the safety controller or safety relay unit.





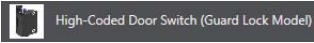
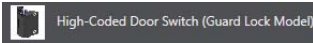
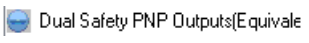
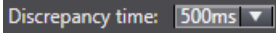

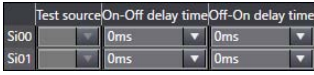
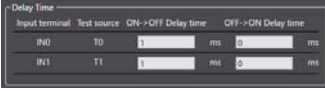
Note: 1. Even when only a single safety door switch is used, apply 24 VDC to safety inputs X1 and X2.

Safety controller settings

OMRON's safety controller		NX-SL and NX-SI 	GI-SMD/SID 	G9SP 
Input device setting	Input device	High-Coded Door Switch (Guard Lock Model) 	High-Coded Door Switch (Guard Lock Model) 	Dual Safety Semiconductor Output (Equivalent) 
	Discrepancy time	Set discrepancy time to 100 ms or more NX-Series Safety Control Unit User's Manual Refer to the Dual Channel Evaluation in Cat. No.Z930. Settings 	Set discrepancy time to 100 ms or more GI-S series Safety I/O Terminal User's Manual Refer to the Dual Channel Evaluation in Cat. No.Z400. Settings 	Set discrepancy time to 0 (disabled) or 100 ms or more G9SP series Safety Controller User's Manual Refer to the Dual Channel Evaluation in Cat. No.Z922. Settings 
	Filtering out test pulses	NX-Series Safety Control Unit User's Manual Refer to the Input Filters in Cat. No.Z930. Settings 	Set input filter ON->OFF delay time to 1 ms or more GI-S series Safety I/O Terminal User's Manual Refer to the Input Filter Function in Cat. No.Z400. Settings 	Set input filter OFF delay time to 1 ms or more G9SP series Safety Controller User's Manual Refer to the Input Filters in Cat. No.Z922. Settings Off On Delay: <input type="text" value="0"/> x 4 = 0 ms (0 ms - 1000 ms) On Off Delay: <input type="text" value="1"/> x 4 = 4 ms (0 ms - 1000 ms)

Note: The ON → OFF delay time affects the response time (safety reaction time) of the system. Add the setting value to the system response time in each controller. For details on calculating the response time, refer to the manual of each controller.

Combination with a safety relay unit

OMRON's safety relay unit		G9SA 	G9SE 	G9SB 	G9SX 
Input device Safety-door switch	D41L	Connectable	Connectable	Connectable	Connectable

* Refer to the instruction manual or user's manual of each product for how to extend the wiring.

Release

Manual Release

For the machine set-up, the safety door switch can be unlocked in a de-energized condition.

The safety door switch is unlocked by turning the manual release in the position (unlock ) .

The normal locking function is only restored after the manual release has been returned to its original position (lock ) .

After being put into operation, the manual release must be sealed by means of the seal, which is included in delivery.

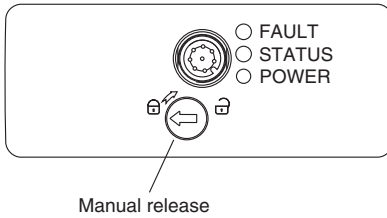

Emergency exit (D41L-□□D□E-N2)

To activate the emergency exit, turn the red lever in the direction of the arrow (1) to the end stop. The safety outputs switch off and the guard system can be opened. The blocked position is cancelled by turning the lever in the opposite direction. In the unlocked position, the guard system is secured against unintentional locking.

With variants that have emergency-exit, the red lever is included with delivery.

The lever should be fastened to the position intended with the supplied screws before first being used.

The lever should be installed on the unlocking triangle in such a way that the arrow (2) on the triangle and the lever pivot are congruent.

The installation of the lever is possible on both sides.

The opposite is to be sealed with the seal included with delivery.

Fitting and actuation only from within the hazardous area.

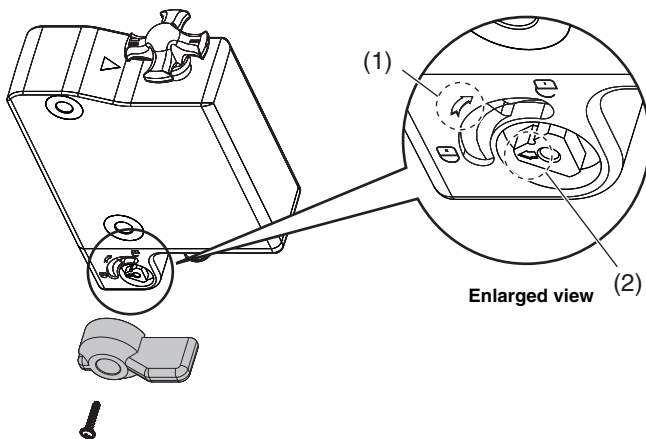

Latching Force Adjustment

Adjustment of the latching force

In order to enable trouble-free functionality of the device, the rotary handle must be in position I or II when the guard door is open.

In the intermediate positions, locking is impossible.

The latching force is changed by turning the rotary handle by 180°.

In position I, the latching force is approx. 25 N.

In position II, the latching force is approx. 50 N.

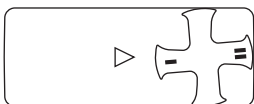

D41L

Teaching

The D41L will require the following teaching procedure to write individual actuator information (code). Saving individual actuator information for identification to the switch through the teaching procedure is called "individual coding".

1. Keep the actuator away from the detection range and switch the safety door switch's voltage supply off and back on.
2. Introduce the actuator in the detection range. The teach-in procedure is signaled at the safety door switch, green LED off, red LED on, yellow LED flashes (1 Hz).
3. After 10 seconds, the yellow LED gives brief cyclic flashes (3 Hz). Switch off the supply voltage of the safety door switch. (If the voltage is not switched off within 5 minutes, the safety door switch cancels the teach-in procedure and signals a false actuator by 5 red flashes).
4. Switch the supply voltage back on. The actuator must be detected once more in order to activate the taught actuator code. In this way, the activated code is definitively saved.

For ordering suffix D41L-1, the thus executed allocation of safety door switch and actuator is irreversible.

When the above procedure is attempted with a D41L-1 which already completed teaching, the teaching procedure will not start.

For ordering suffix D41L-2, the teach-in procedure for a new actuator can be repeated an unlimited number of times. When a new actuator is taught, the code, which was applicable until that moment, becomes invalid.

Subsequent to that, the safety outputs (OSSD) will be disabled for ten minutes, thus providing for an increased protection against intentional tampering.

The green LED will flash until the expiration of the time (10 minutes) of the enabling inhibit and the detection of the new actuator. In case of power failure during the lapse of time, the 10-minutes tampering protection time will restart.

When the above procedure is attempted with a combination of D41L-2 and actuator which already completed teaching, the teaching procedure will not start.

The D41L-A Actuator can be taught an unlimited number of times. This allows the actuator taught by the D41L-1 to be taught again by the D41L-2 with no teaching limitation instead of the D41L-1 with teaching limitation.

Operating Principle

Magnet control

In the power-to-unlock version of the D41L, the safety door switch is unlocked when the Solenoid Control signal (= 24V) is set. In the power-to-lock version of the D41L, the safety door switch is locked when the Solenoid Control signal (= 24 V) is set.

If the risk analysis indicates the use of a monitored interlock then a variant with the monitored interlock (D41L-□Y) is to be used, labelled with the symbol ().

The locking function of the actuator monitoring model (D41L-□Z) cannot be used for safety purposes. Use it for process protection.

Mode of operation of the safety outputs

In the interlock monitoring model (D41L-□Y), the unlocking of the safety door switch causes the safety outputs (OSSD) to be disabled. The unlocked safety door switch can be relocked as long as the actuator is inserted in the switch. In that case, the safety outputs (OSSD) are re-enabled. In the actuator monitoring model (D41L-□Z), the opening of the guard door causes the safety outputs to be disabled. (Locking is not monitored.)

If the safety outputs (OSSD) are already enabled, any error that does not immediately affect the functionality of the safety door switch (e.g. too high ambient temperature, interference potential at the safety outputs, cross-wire short) will lead to a warning message, disabling of the auxiliary output and a delayed shutdown of the safety outputs. (Refer to *Troubleshooting* on page 17.)

Safety outputs are disabled if the error warning is active for 30 minutes. The signal combination, auxiliary output disabled and safety channels still enabled, can be used to stop the production process in a controlled manner. After the rectification of the error, the error message is reset by opening the corresponding guard door.

Emergency exit (D41L-□□D□E-N2)

- Interlock type (D41L-□Y): When the lock is released with the emergency exit lever, the safety outputs (OSSD) turn OFF.
- Actuator monitoring type (D41L-□Z): The safety outputs (OSSD) remain ON even when the lock is released with the emergency exit lever.

Diagnostic Function

Diagnostic LEDs

The safety door switch signals the operating condition, as well as errors through 3-color LEDs.

Green (Power): Supply voltage on

Yellow (Status): Operating condition

Red (Fault): Error (refer to Table)

Safety door switch with conventional auxiliary output

The auxiliary output OUT can be used for central visualization or control functions, e.g. in a PLC.

The auxiliary output is not a safety-related output.

Behavior of the diagnostic output

(Example: power-to-unlock version)

Solenoid Control signal was input

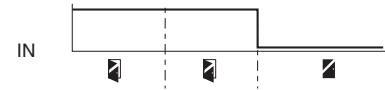

Normal sequence, door was locked

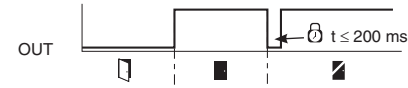

Door could not be locked or fault



Key

- Guard door open
- Guard door closed
- Unlock guard door
- Guard door locked
- Locking time $t \leq 200$ ms
- Guard door not locked or fault

Table 1: Diagnostic information Safety door switch

The switch indicates the operating condition and faults by means of its three-color LED (green, red, and yellow).

System condition	Solenoid control (IN)		LED			Safety outputs Y1, Y2		Auxiliary output OUT
	Power-to-unlock	Power-to-lock	Green	Red	Yellow	D41L-□Y	D41L-□Z	
Guard open	24 V (0 V)	0 V (24 V)	On	Off	Off	0 V	0 V	0 V
Door closed, not locked	24 V	0 V	On	Off	Flashes	0 V	24 V	24 V
Door closed, locking impossible	0 V	24 V	On	Off	Flashes	0 V	24 V	0 V
Door closed and locked	0 V	24 V	On	Off	On	24 V	24 V	24 V
Error warning *1	0 V	24 V	On	Flashes *2	On	24 V *1	24 V *1	0 V
Error	0 V (24 V)	24 V (0 V)	On	Flashes *2	Off	0 V	0 V	0 V
Additionally for variant D41L-1/-2:								
Teach-in procedure actuator started	-	-	Off	On	Flashes	0 V	0 V	0 V
Only D41L-2: Tampering protection time *3	-	-	Flashes	Off	Off	0 V	0 V	0 V

*1. Unless error (warning) causes are eliminated within 30 minutes, the safety outputs are disabled after being enabled for 30 minutes.

*2. Refer to Table 2: Error message/LED indication (red).

*3. Refer to *Teaching* on page 12.

Table 2: Error message/LED indication (red)

Flash codes (Red)	Designation	Autonomous switch-off after	Error cause
1 flash pulse	Error (warning) at output Y1	30 min	Fault in output test or voltage at output Y1, although the output is disabled.
2 flash pulses	Error (warning) at output Y2	30 min	Fault in output test or voltage at output Y2, although the output is disabled.
3 flash pulses	Error (warning) cross-wire short	30 min	Cross-wire short between the output cables or fault at both outputs
4 flash pulses	Error (warning) temperature too high	30 min	The temperature measurement reveals an internal temperature that is too high
5 flash pulses	Actuator fault	0 min	Incorrect or defective actuator, bracket broken
6 flash pulses	Fault rotary handle	0 min	Rotary handle not in authorised intermediate position
Continuous red signal	Internal fault/overvoltage or undervoltage fault	0 min	Machine failure/supply voltage not within specifications

D41L

Dimensions

(Unit: mm)

Switch

D41L-□□D□-N2

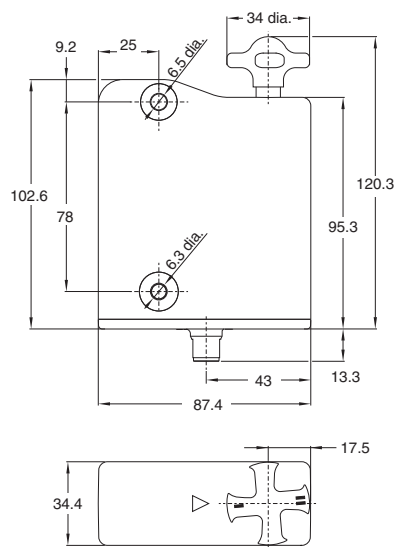

D41L-□□DE-N2

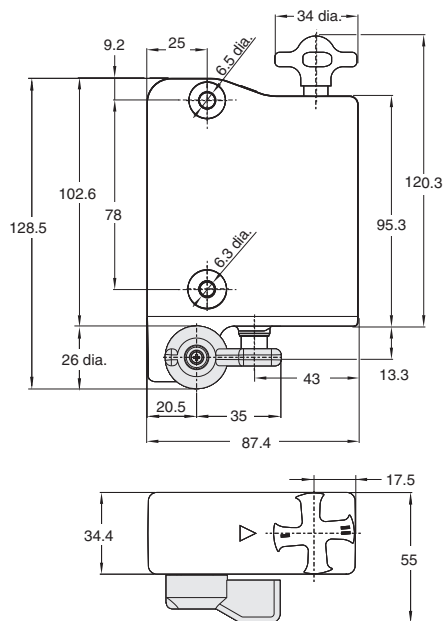

Actuator (Sold separately)

D41L-A1

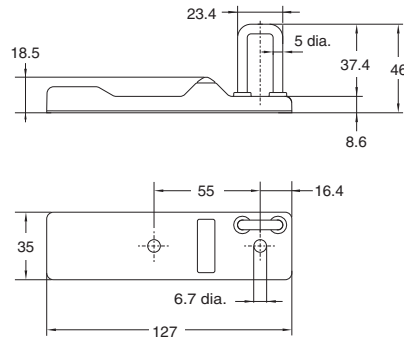

Accessory (Sold separately)

Mounting plate/Mounting Set

Mounting plate
D41L-MP

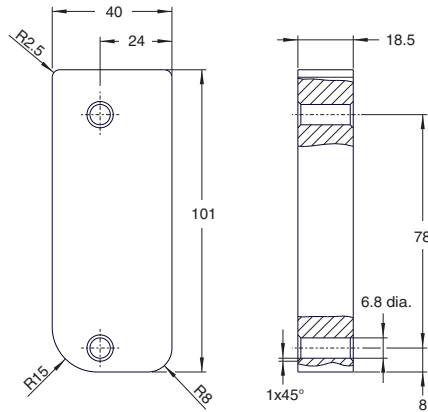

D41L

Mounting

For the correct fixing of the safety door switch and the actuator, two mounting holes for M6 screws are provided (tightening torque: 6 to 7 N•m).

Any mounting position. The system must only be operated with an angle of $\leq 2^\circ$ between the safety door switch and the actuator.

The actuator must be permanently fitted to the safety guard and protected against displacement by suitable measures (tamperproof screws, gluing, drilling of the screw heads, pinning).

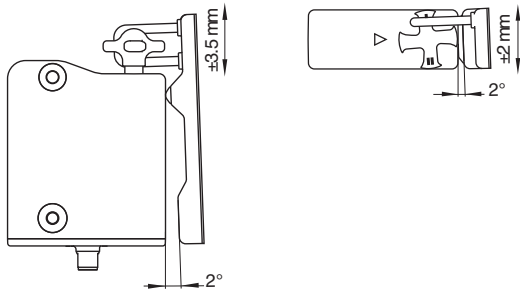

Accessories for installation (Mounting plate (D41L-MP))

It can be installed by using the following for the type to be installed on the same side as the door frame.

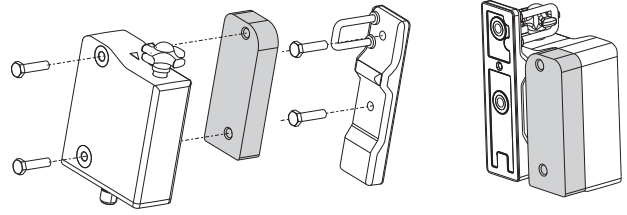

Actuating directions

Provide for a sufficient insertion of the actuator into the rotary handle.

Correct

False

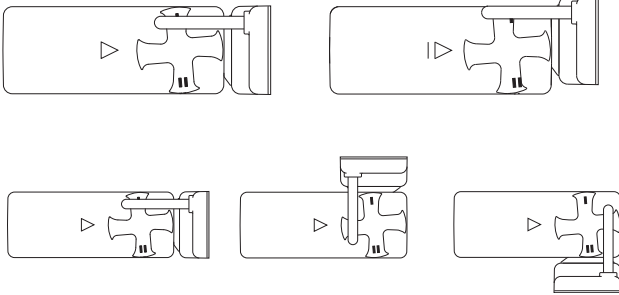

The diagrams show a closed guard system with a set latching force of 50 N

To avoid any interference inherent to this kind of system and any reduction of the switching distances, please observe the following guidelines:

- The presence of metal chips in the vicinity of the safety door switch is liable to modify the switching distance.
- Keep away from metal chips.

Minimum distance between two safety door switches as well as other systems with same frequency (125 kHz)

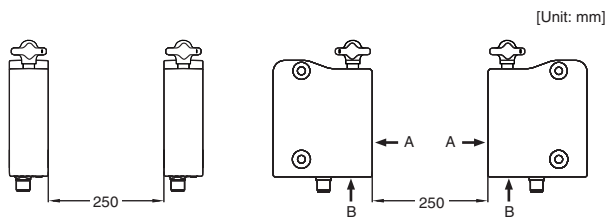

The minimum distance from metallic securing surfaces to the face side "A" and underside "B" of the device is 5 mm.

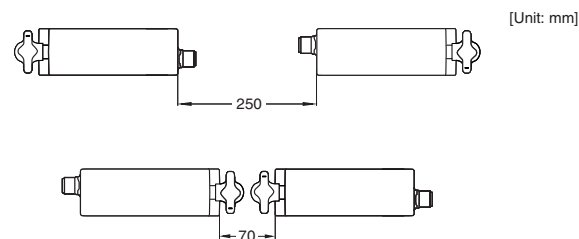

Troubleshooting

Operation in case of errors

Errors that no longer guarantee the function of the safety door switch (internal errors) cause the safety outputs (OSSD) to be disabled immediately. Any error that does not immediately affect the safe functionality of the safety door switch (e.g. too high ambient temperature, interference potential at the safety outputs (OSSD), cross-wire short) will lead to a warning message, disabling of the auxiliary output and a delayed shutdown of the safety outputs. (Refer to Table 2.)

After fault rectification, the error message is reset by opening and re-closing the corresponding guard door.

The switch will go into the lockout state if more than one fault is detected in the switch or a short circuit is detected between safety outputs Y1 and Y2. To reset this type of lockout, the power to the safety door switch must be cycled after elimination of the error causes such as faults and short-circuits.

Error warnings

When an error (warning) occurs, the safety outputs (OSSD) are disabled after being enabled for 30 minutes.

After the error cause is removed, the warning indication (e.g., LED flashes) is reset.

Table 1: Diagnostic information Safety door switch

The switch indicates the operating condition and faults by means of its three-color LED (green, red, and yellow).

System condition	Solenoid control (IN)		LED			Safety outputs Y1, Y2		Auxiliary output OUT
	Power-to-unlock	Power-to-lock	Green	Red	Yellow	D41L-□Y	D41L-□Z	
Guard open	24 V (0 V)	0 V (24 V)	On	Off	Off	0 V	0 V	0 V
Door closed, not locked	24 V	0 V	On	Off	Flashes	0 V	24 V	24 V
Door closed, locking impossible	0 V	24 V	On	Off	Flashes	0 V	24 V	0 V
Door closed and locked	0 V	24 V	On	Off	On	24 V	24 V	24 V
Error warning *1	0 V	24 V	On	Flashes *2	On	24 V *1	24 V *1	0 V
Error	0 V (24 V)	24 V (0 V)	On	Flashes *2	Off	0 V	0 V	0 V
Additionally for variant D41L-1/-2:								
Teach-in procedure actuator started	-	-	Off	On	Flashes	0 V	0 V	0 V
Only D41L-2: Tampering protection time *3	-	-	Flashes	Off	Off	0 V	0 V	0 V

*1. Unless error (warning) causes are eliminated within 30 minutes, the safety outputs are disabled after being enabled for 30 minutes.

*2. Refer to Table 2: Error message/LED indication (red).

*3. Refer to *Teaching* on page 12.

Table 2: Error message/LED indication (red)

Flash codes (Red)	Designation	Autonomous switch-off after	Error cause
1 flash pulse	Error (warning) at output Y1	30 min	Fault in output test or voltage at output Y1, although the output is disabled.
2 flash pulses	Error (warning) at output Y2	30 min	Fault in output test or voltage at output Y2, although the output is disabled.
3 flash pulses	Error (warning) cross-wire short	30 min	Cross-wire short between the output cables or fault at both outputs
4 flash pulses	Error (warning) temperature too high	30 min	The temperature measurement reveals an internal temperature that is too high
5 flash pulses	Actuator fault	0 min	Incorrect or defective actuator, bracket broken
6 flash pulses	Fault rotary handle	0 min	Rotary handle not in authorised intermediate position
Continuous red signal	Internal fault/overvoltage or undervoltage fault	0 min	Machine failure/supply voltage not within specifications



Safety Precautions

Be sure to read the precautions for all models in the website at: <http://www.ia.omron.com/>.

Warning Indications

 WARNING	Indicates a potentially hazardous situation which, if not avoided, will result in minor or moderate injury, or may result in serious injury or death. Additionally there may be significant property damage.
Precautions for Safe Use	Supplementary comments on what to do or avoid doing, to use the product safely.
Precautions for Correct Use	Supplementary comments on what to do or avoid doing, to prevent failure to operate, or undesirable effect on product performance.

Meaning of Product Safety Symbols

	General prohibition Instructions on unspecified prohibited action.
	General instructions Instructions on unspecified general action.

Alert Statements

 **WARNING**

Use only appropriate components or devices complying with relevant safety standards corresponding to the required performance level and safety category. Failure to do so may result in serious injury or death. Conformity to requirements of the performance level and safety category must be determined as an entire system. It is recommended to consult a certification body regarding assessment of conformity to the required safety level.



Do not apply DC voltages exceeding the rated voltages, nor any AC voltages to the product. Failure to do so may result in serious injury or death.



Install the switch and actuator in a position where the opening of the guard door can be detected within a safe distance. Failure to do so may result in serious injury or death.



Do not apply force exceeding the specified holding force (Fzh). Either install another locking component (e.g., a hook) in addition to the product, or use a warning measures or an indicator showing the controlled system is locked to avoid overloading the holding force in lock mode. Failure to do so may result in serious injury or death.



When complying with safety standards, install the product in an appropriate manner in accordance with ISO 14119, with due consideration of the risk of defeat by the operator. Failure to do so may result in serious injury or death.



Make sure that the DC power supply meets the following items. Failure to do so may result in serious injury or death.

- Satisfies the requirements of PELV power supply defined in IEC 60204-1.
- Satisfies the requirements of class 2 circuits defined in UL508.



Precautions for Safe Use

1. Disconnect the product from power supply when wiring the product. Failure to do so may cause unexpected operation of devices connected to the product.
2. Wire the input and output terminals correctly and verify the correct operation of the product before using the system in which the product is incorporated. Incorrect wiring may lead to loss of the safety function.
3. Install the actuator in a place where it will not come in contact with your body when opening or closing the guard door. Failure to do so may result in injury.
4. Do not use the product in any direction other than the specified mounting orientations of the main body and actuator.
5. Dispose of the product in accordance with the laws set by each country.

Precautions for Correct Use

1. Do not drop the product to the ground or expose to excessive vibration or mechanical shocks. Doing so may damage the product and cause failure.
2. Do not store or use the product under the following conditions. Doing so may damage the product and cause failure.
 - 1) At ambient operating temperatures out of the range of 0 to 60°C
 - 2) At ambient storage temperatures out of the range of -10 to 90°C
 - 3) At relative humidity of 93% or more
 - 4) In direct sunlight
 - 5) Under drastic temperature changes
 - 6) In high humidity that causes condensation
3. Keep the product away from oil or solvent. Oil or solvent make the marking on the product illegible and cause deterioration of some parts.
4. Do not use in an environment with corrosive gas.
5. The product may not operate normally in the vicinity of devices that generate strong radio waves or magnetic fields, such as RFID systems, proximity sensors, motors, inverters, and switch-mode power supplies. If the device is used in the vicinity of such devices, check the effect before use.
6. Installing the switch and the actuator on a metallic material may affect the operating distance. If installation on a metallic material is necessary, be sure to check the effect on the operating distance before use.
7. Tighten the screws with a specified torque.
8. Use the wires specified by OMRON to wire the product. (Refer to Connection.)
9. Do not extend the cables in excess of the specification of this product. Carry out electrical connection according to the wiring examples shown in this document and verify the correct operation of the product.
10. Do not pull or bend the cable excessively. A disconnection may cause a malfunction.
11. Risk time remains unchanged by series connection. However, carry out electrical connection according to the wiring examples shown in this document.
12. Be sure to inspect the product daily and every 6 months. Failure to do so may cause a system failure and serious injury.
13. When determining the safety distance, take into account the delay of the output of the product caused by the response time. Failure to do so may cause the operator to reach the hazardous source before the machine is stopped, resulting in serious injury.
14. During installation, make sure that the safety door switch does not come in contact with the actuator due to rattling of the guard door. (The performance of the product may be degraded by a collision caused by opening or closing the guard door.)
15. Install the product so that the LED indicators of the safety door switch are as visible as possible. Misinterpreting the status of the safety door switch may result in danger.
16. Do not use the product at an altitude of 2,000 m or higher.
17. Do not connect a product different from this product in series with this product. Doing so may disturb waveforms of the input and output signals, leading to loss of the safety function.
18. Do not use the product in the water or continuous water exposure environment. Doing so may cause water to leak into the product. (The degree of protection does not guarantee the protection under continuous water exposure environment.)
19. Do not tamper the product with a replacement actuator. Store replacement actuators in a safe place where they cannot be easily reached.
20. Build a safety system using the outputs of both Safety Outputs 1 and 2. Wiring with only one safety output may lead to loss of the safety function due to a single failure.
21. Wiring should meet the requirements specified in Section 9.4.3 of IEC 60204-1 to prevent malfunction due to ground faults in the safety output lines.
22. In the power-to-lock type, close the door before energizing the safety door switch.
23. In the power-to-lock type, the safety door switch is locked only when the solenoid is energized. If the solenoid is de-energized due to a sudden power failure, the operator may be exposed to a hazardous source. Use the power-to-lock type only for process protection.
24. Do not use the emergency-exit type for switching the machine on and off. Doing so may place operators at risk due to being trapped inside or unexpected operation of the machine.
25. Install the emergency-exit type so that it cannot be operated from outside a safety zone.
26. Do not apply excessive force on the actuator while the actuator is inserted into the switch body or do not drop the product. Doing so may deform the actuator or damage the switch body.
27. The safety function may not operate normally due to a malfunction of the wiring, setting, or switch, and the machine may continue to operate, which may result in personal injury. Make sure that the safety function works before starting operation.
28. The current consumption of the safety door switch is different between when it is turned on and when it is in a normal operation. Apply the supply voltage to the safety door switch in consideration of the voltage drop in the wiring.
29. Do not turn beyond the latching point. After being put into operation, the manual release must be secured by closing the flap cover with the seal, which is included in delivery.
30. After installation of the product, qualified personnel should verify to see that the installation, inspection, and maintenance are properly performed. The qualified personnel should be qualified and authorized to secure the safety on each phase of design, installation, running, maintenance and disposal of system.
31. Do not wire the product to an input of a safety controller in parallel.
32. Disconnect the product and the controller connected to the product from power supply when replacing the product. Failure to do so may cause unexpected operation of devices connected to the product.
33. Install the product to a position near a handle of the guard door. Installing it near a hinge may cause the locking part of the product to receive larger load than the operating force, leading to damage to the locking mechanism.
34. Do not try to disassemble, repair, or modify the product. Doing so may cause loss of the safety function.
35. Do not operate the product in an environment with flammable or explosive gas.
36. Auxiliary output is NOT a safety output. Do not use the Auxiliary output individually for any safety function. Such incorrect use causes loss of the safety function of the product and its relevant systems.

Set-up and Maintenance/Disassembly and Disposal

Set-up and Maintenance

Functional testing

The safety function of the safety components must be tested.

The following conditions must be previously checked and met:

1. Check maximum. axial misalignment of actuator and safety door switch.
2. Check maximum. angular misalignment. (Refer to Mounting.)
3. Fitting and integrity of the cable connections.
4. Check the switch enclosure for damage.
5. Remove particles of dust and soiling.
6. For variants with an emergency exit, the following is to be considered:

Note: 1. For variants with emergency exits it should be possible to open the guard door inside the hazardous area; it should not be possible to lock the guard door from inside.

Maintenance

Maintenance frequency

SIL3 / PLe at least once a month

SIL2 / PLd at least once a year

(Daily inspection)

- For each guard door, check that the machine stops when the guard door opens.

(Inspection every 6 months)

- Check for a secure installation of the actuator and the safety door switch
- Check maximum. axial misalignment of actuator and safety door switch.
- Check maximum. angular misalignment. (Refer to Mounting.)
- Fitting and integrity of the cable connections.
- Check the switch enclosure for damages
- Remove soiling

Disassembly and Disposal

Disassembly

The product must be disassembled in a de-energized condition only.

Disposal

The product must be disposed of in an appropriate manner in accordance with the national prescriptions and legislations.

Terms and Conditions Agreement

Read and understand this catalog.

Please read and understand this catalog before purchasing the products. Please consult your OMRON representative if you have any questions or comments.

Warranties.

(a) Exclusive Warranty. Omron's exclusive warranty is that the Products will be free from defects in materials and workmanship for a period of twelve months from the date of sale by Omron (or such other period expressed in writing by Omron). Omron disclaims all other warranties, express or implied.

(b) Limitations. OMRON MAKES NO WARRANTY OR REPRESENTATION, EXPRESS OR IMPLIED, ABOUT NON-INFRINGEMENT, MERCHANTABILITY OR FITNESS FOR A PARTICULAR PURPOSE OF THE PRODUCTS. BUYER ACKNOWLEDGES THAT IT ALONE HAS DETERMINED THAT THE PRODUCTS WILL SUITABLY MEET THE REQUIREMENTS OF THEIR INTENDED USE.

Omron further disclaims all warranties and responsibility of any type for claims or expenses based on infringement by the Products or otherwise of any intellectual property right. (c) Buyer Remedy. Omron's sole obligation hereunder shall be, at Omron's election, to (i) replace (in the form originally shipped with Buyer responsible for labor charges for removal or replacement thereof) the non-complying Product, (ii) repair the non-complying Product, or (iii) repay or credit Buyer an amount equal to the purchase price of the non-complying Product; provided that in no event shall Omron be responsible for warranty, repair, indemnity or any other claims or expenses regarding the Products unless Omron's analysis confirms that the Products were properly handled, stored, installed and maintained and not subject to contamination, abuse, misuse or inappropriate modification. Return of any Products by Buyer must be approved in writing by Omron before shipment. Omron Companies shall not be liable for the suitability or unsuitability or the results from the use of Products in combination with any electrical or electronic components, circuits, system assemblies or any other materials or substances or environments. Any advice, recommendations or information given orally or in writing, are not to be construed as an amendment or addition to the above warranty.

See <http://www.omron.com/global/> or contact your Omron representative for published information.

Limitation on Liability; Etc.

OMRON COMPANIES SHALL NOT BE LIABLE FOR SPECIAL, INDIRECT, INCIDENTAL, OR CONSEQUENTIAL DAMAGES, LOSS OF PROFITS OR PRODUCTION OR COMMERCIAL LOSS IN ANY WAY CONNECTED WITH THE PRODUCTS, WHETHER SUCH CLAIM IS BASED IN CONTRACT, WARRANTY, NEGLIGENCE OR STRICT LIABILITY.

Further, in no event shall liability of Omron Companies exceed the individual price of the Product on which liability is asserted.

Suitability of Use.

Omron Companies shall not be responsible for conformity with any standards, codes or regulations which apply to the combination of the Product in the Buyer's application or use of the Product. At Buyer's request, Omron will provide applicable third party certification documents identifying ratings and limitations of use which apply to the Product. This information by itself is not sufficient for a complete determination of the suitability of the Product in combination with the end product, machine, system, or other application or use. Buyer shall be solely responsible for determining appropriateness of the particular Product with respect to Buyer's application, product or system. Buyer shall take application responsibility in all cases.

NEVER USE THE PRODUCT FOR AN APPLICATION INVOLVING SERIOUS RISK TO LIFE OR PROPERTY OR IN LARGE QUANTITIES WITHOUT ENSURING THAT THE SYSTEM AS A WHOLE HAS BEEN DESIGNED TO ADDRESS THE RISKS, AND THAT THE OMRON PRODUCT(S) IS PROPERLY RATED AND INSTALLED FOR THE INTENDED USE WITHIN THE OVERALL EQUIPMENT OR SYSTEM.

Programmable Products.

Omron Companies shall not be responsible for the user's programming of a programmable Product, or any consequence thereof.

Performance Data.

Data presented in Omron Company websites, catalogs and other materials is provided as a guide for the user in determining suitability and does not constitute a warranty. It may represent the result of Omron's test conditions, and the user must correlate it to actual application requirements. Actual performance is subject to the Omron's Warranty and Limitations of Liability.

Change in Specifications.

Product specifications and accessories may be changed at any time based on improvements and other reasons. It is our practice to change part numbers when published ratings or features are changed, or when significant construction changes are made. However, some specifications of the Product may be changed without any notice. When in doubt, special part numbers may be assigned to fix or establish key specifications for your application. Please consult with your Omron's representative at any time to confirm actual specifications of purchased Product.

Errors and Omissions.

Information presented by Omron Companies has been checked and is believed to be accurate; however, no responsibility is assumed for clerical, typographical or proofreading errors or omissions.

High-Coded Safety Door Switch

High Coded Non-Contact Safety Door Switch D41D (No.F112)

High Coded Guard Lock Safety Door Switch D41L (No.F113)

High-Coded Guard Lock (For Gate) Safety Door Switch D41G (No.F114)

Note: Do not use this document to operate the Unit.

OMRON Corporation Industrial Automation Company
Kyoto, JAPAN

Contact: www.ia.omron.com

Regional Headquarters

OMRON EUROPE B.V.
Wegalaan 67-69, 2132 JD Hoofddorp
The Netherlands
Tel: (31)2356-81-300/Fax: (31)2356-81-388

OMRON ELECTRONICS LLC
2895 Greenspoint Parkway, Suite 200
Hoffman Estates, IL 60169 U.S.A.
Tel: (1) 847-843-7900/Fax: (1) 847-843-7787

OMRON ASIA PACIFIC PTE. LTD.
438B Alexandra Road, #08-01/02 Alexandra
Technopark, Singapore 119968
Tel: (65) 6835-3011/Fax: (65) 6835-2711

OMRON (CHINA) CO., LTD.
Room 2211, Bank of China Tower,
200 Yin Cheng Zhong Road,
PuDong New Area, Shanghai, 200120, China
Tel: (86) 21-5037-2222/Fax: (86) 21-5037-2200

Authorized Distributor:

© OMRON Corporation 2021-2022 All Rights Reserved.
In the interest of product improvement,
specifications are subject to change without notice.

CSM_3_1
Cat. No. F113-E1-03

0322 (0321)