

Safety Laser Scanner OS32C

OS32C Safety Laser Scanner

- Type 3 Safety Laser Scanner complies with IEC61496-1/-3.
- 70 sets of safety zone and warning zone combinations are available, supporting complicated changes in working environments.
- A safety radius up to 4 m and warning zone(s) radius up to 15 m can be set.
- Configurable minimum object resolution of 30, 40, 50 or 70 mm, for hand and arm detection applications
- 8 Individual Sector Indicators and various LED indications allow the user to determine scanner status at a glance.
- Reference Boundary Monitoring function prevents unauthorized changes in the scanner position.





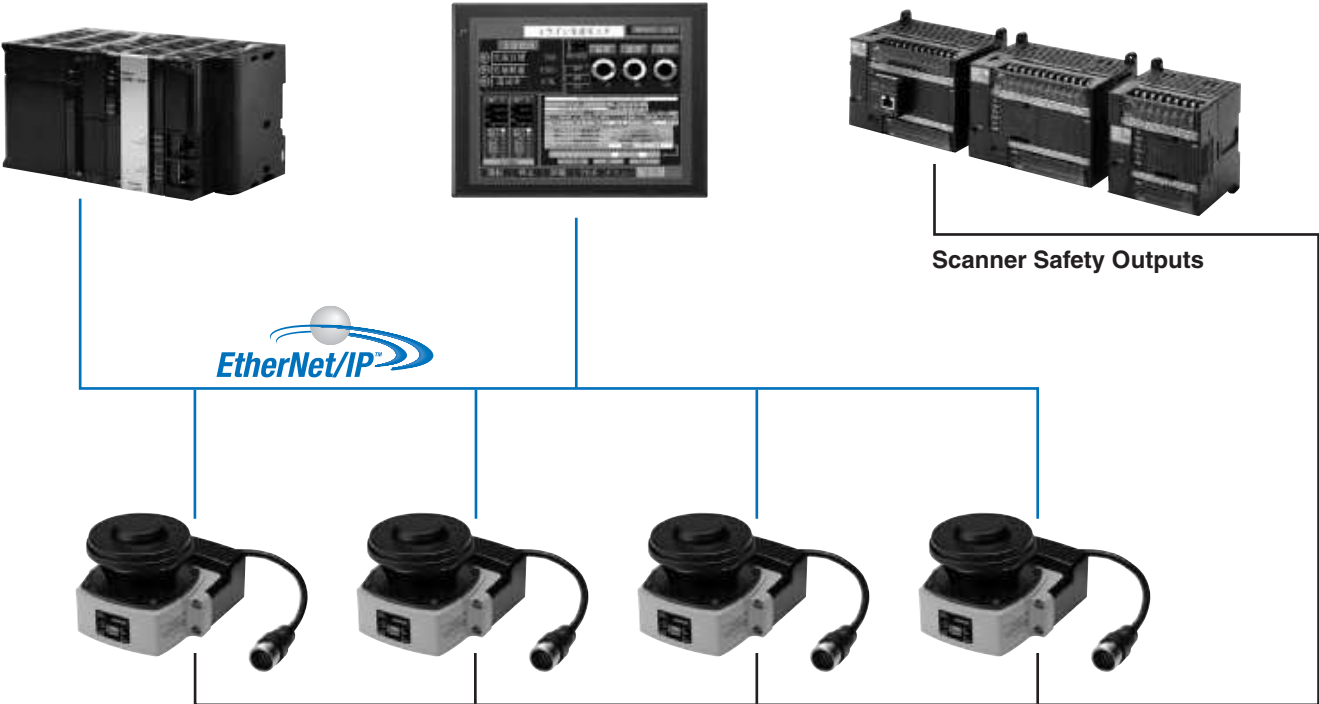

EtherNet/IP for Status and Measurement Data

The OS32C with EtherNet/IP can be monitored by ODVA EtherNet/IP compliant products such as PLCs and HMIs. System status, zone status, and measurement data can all be monitored over EtherNet/IP.



Ordering information

OS32C (Power cable is sold separately.)

Appearance	Description	Max. Operating Range (Safety Zone)	Model	Remarks
	OS32C with back location cable entry	3 m	OS32C-BP	CD-ROM (Configuration tool) OS supported: - Windows 2000, - Windows XP (32-bit version, Service Pack 3 or later) - Windows Vista (32-bit version), - Windows 7 (32-bit version/64-bit version) For configuration tool version, refer to page 9.
		4 m	OS32C-BP-4M	
	OS32C with side location cable entry ^{*1}	3 m	OS32C-SP1	
		4 m	OS32C-SP1-4M	
	OS32C with Ethernet/IP and back location cable entry	3 m	OS32C-BP-DM	
		4 m	OS32C-BP-DM-4M	
	OS32C with Ethernet/IP and side location cable entry ^{*1}	3 m	OS32C-SP1-DM	
		4 m	OS32C-SP1-DM-4M	

*1. For OS32C-SP1(-DM), each connector is located on the left as viewed from the back of the I/O block.

Power cable





Appearance	Description	Model	Remarks
	Cable length: 3 m	OS32C-CBL-03M	One cable is required per sensor.
	Cable length: 10 m	OS32C-CBL-10M	
	Cable length: 20 m	OS32C-CBL-20M	
	Cable length: 30 m	OS32C-CBL-30M	

Ethernet cable

Appearance	Description	Model	Remarks
	Cable length: 2 m	OS32C-ECBL-02M	Required for configuration and monitoring.
	Cable length: 5 m	OS32C-ECBL-05M	
	Cable length: 15 m	OS32C-ECBL-15M	

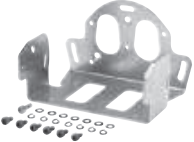



Note: An ethernet cable with an M12, 4-pin connector is required.

Mounting brackets

Appearance	Description	Model	Remarks
	Bottom/side mounting bracket	OS32C-BKT1	Bottom/side mounting bracket × 1, unit mounting screws × 4 sets
	XY axis rotation mounting bracket	OS32C-BKT2	XY axis rotation mounting bracket × 1, unit mounting screws × 6 sets, bracket mounting screws × 1 set (must be used with OS32C-BKT1)
	Simple mounting bracket	OS32C-BKT3	Simple mounting brackets × 2, unit mounting screws × 4 sets ^{*1}
	Protective cover for window	OS32C-BKT4	
	Mounting stand	OS32C-MT	When using a mounting stand, use an OS32C with side location cable entry (OS32C-SP1). The OS32C with back location cable entry (OS32C-BP) cannot be mounted. Use with mounting brackets (OS32C-BKT1 and OS32C-BKT2).
	Hardware kit for mounting stand	OS32C-HDT	Mounting screws × 3 sets Use this when mounting a bracket to the mounting stand.

*1. There are eight OS32C mounting screws: four screws for singular use, and four screws for protective cover for window.

Accessories

Appearance	Description		Model	Remarks
	Scan window		OS32C-WIN-KT	Spare for replacement
	Sensor block without I/O block Max. Operating Range: 3 m		OS32C-SN	Spare for replacement
	Sensor block without I/O block Max. Operating Range: 4 m		OS32C-SN-4M	
	Sensor block without I/O block for EtherNet/IP Max. Operating Range: 3 m		OS32C-SN-DM	Spare replacement for EtherNet/IP
	Sensor block without I/O block for EtherNet/IP Max. Operating Range: 4 m		OS32C-SN-DM-4M	
	I/O block	With cable access from the back	OS32C-CBBP	Spare for replacement
		With cable access from the left side	OS32C-CBSP1	
	Window cleaning kit, anti-static cleaner		WIN-CLN-KT	Accessory

Rating/Performance

Sensor Type		Type 3 Safety Laser Scanner
Safety Category		PLd/Safety Category 3 (ISO 13849-1)
Detection Capability		Configurable; Non-transparent with a diameter of 30, 40, 50, 70 mm (1.8% reflectivity or greater) (default: 70 mm)
Monitoring Zone		Monitoring Zone Set Count: (Safety Zone + 2 Warning Zones) x 70 sets
Operating Range	OS32C-□□□□	Safety Zone: 1.75 m (min. obj. resolution of 30 mm) 2.5 m (min. obj. resolution of 40 mm) 3.0 m (min. obj. resolution of 50 mm or 70 mm) Warning Zone: 10.0 m
	OS32C-□□□□-4M	Safety Zone: 1.75 m (min. object resolution of 30 mm) 2.5 m (min. object resolution of 40 mm) 3.0 m (min. object resolution of 50 mm or 70 mm) 4.0 m (min. object resolution of 70 mm) Warning Zone: 15.0 m
Maximum Measurement Error		100 mm (at range of 3 m or less) ^{*1} 110 mm (at distance greater than 3 m and up to 4 m) ^{*1}
Detection Angle		270°
Angular Resolution		0.4°
Laser Beam Diameter		6 mm at optics cover, 14 mm (typical) at 3 m.
Laser Scan Plane Height		67 mm from the bottom of the scanner (see "Dimensions" on page 8 for more detail.)
Response Time		Response time from ON to OFF: From 80 ms (2 scans) to 680 ms (up to 17 scans) ^{*2} Response time from OFF to ON: Response time from ON to OFF + 100 ms to 60 s (Configurable)
Zone Switching Time		20 to 320 ms
Line Voltage		24 VDC +25%/-30% (ripple p-p 2.5 V max.)
Power Consumption		Normal operation: 5 W max., 4 W typical (without output load) ^{*3} Standby mode: 3.75 W (without output load)
Emission Source (Wavelength)		Infrared Laser Diode (905 nm)
Laser Protection Class		Class 1: IEC/EN60825-1 (2007) Class 1: JIS C 6802 (2005) Class I: CFR21 1040.10, 1040.11
Safety Output (OSSD)		PNP transistor x 2, load current of 250 mA max., residual voltage of 2 V max., load capacity of 2.2 µf max., leak current of 1 mA max. ^{*3,*4,*5}
Auxiliary Output (Non-Safety)		NPN/PNP transistor x 1, load current of 100 mA max., residual voltage of 2 V max., leak current of 1 mA max. ^{*4,*5,*6}
Warning Output (Non-Safety)		NPN/PNP transistor x 1, load current of 100 mA max., residual voltage of 2 V max., leak current of 1 mA max. ^{*4,*5,*6}
Operation Mode		Auto Start, Start Interlock, Start/Restart Interlock
Input	External Device Monitoring (EDM)	ON: 0 V short (input current of 50 mA), OFF: Open
	Start	ON: 0 V short (input current of 20 mA), OFF: Open
	Zone Select	ON: 24 V short (input current of 5 mA), OFF: Open
	Stand-by	ON: 24 V short (input current of 5 mA max.), OFF: Open
Connection Type		Power Cable: 18-pin mini-connector (pigtail) Communication Cable: M12, 4-pin connector
Connection with PC		Communication: Ethernet ^{*7} OS Supported: Windows 2000, Windows XP (32-bit version, Service Pack 3 or later), Windows Vista (32-bit version), Windows 7 (32-bit version/64-bit version)
Indicators		RUN indicator: Green, STOP indicator: Red, Interlock Indicator: Yellow, Warning/Auxiliary Output Indicator: Orange Status/Diagnostic Display: 2 x 7-segment LEDs, Individual Sector Indicators: Red LED x 8
Protective Circuit		Protection against output load short and reverse power connection
Ambient Temperature		Operation: -10 to 50°C, Storage: -25 to 70°C
Ambient Humidity		Operation & Storage: 95% RH max., non-condensing
Ambient Operation Illumination		Incandescent lamp: Illumination on receiving surface 1500 lx max. (an angle of laser scanning plane and disturbance light must be ±5 degrees or more)
Insulation Resistance		20 MΩ or higher (500 VDC)
Dielectric Withstand Voltage		500 VDC, 1 minute
Enclosure Rating		IP65 (IEC60529)
Enclosure		Sensor head: Die-cast aluminum, optical cover: Polycarbonate, I/O block: Die-cast aluminum
Dimensions (WxHxD)		133.0 x 104.5 x 142.7 mm (except cable)

Impact Resistance	98 m/s ² 1,000 times for each of X, Y, and Z directions (IEC60068-2-29)
Vibration	10 to 55 Hz double-amplitude of 0.7 mm, 20 sweepings for X, Y, and Z directions (IEC60068-2-6)
Weight (Main Unit only)	1.3 kg
Power Cable	Up to 30 m
Communication Cable	Up to 100 m for 100BASE-TX cable
Approvals	Certificated by: TÜV Rheinland, UL Standards: EN61496-1 (Type 3 ESPE), EN61496-3 (Type 3 AOPDDR), EN61508 (SIL2), IEC61496-1 (Type 3 ESPE), IEC61496-3 (Type 3 AOPDDR), IEC61508 (SIL2), UL508, UL1998, CAN/CSA-C22.2 No. 14, CAN/CSA-C22.2 No. 0.8

- *1. An additional measurement error may need to be added due to reflective backgrounds.
- *2. Pollution Tolerance mode will add 6 ms to each scan time.
- *3. Rated current of OS32C is 1.025 A max. (OS32C 210 mA + OSSD A load + OSSD B load + Auxiliary output load + Warning output load + Functional Inputs). Where functional inputs are: EDM input ... 50 mA Start input ... 20 mA Standby input ... 5 mA Zone X input ... 5 mA x 8 (eight zone set select inputs)
- *4. Output voltage is Input voltage - 2.0 VDC.
- *5. Total consumption current of 2 OSSDs, auxiliary output, and warning output must not exceed 700 mA.
- *6. Output polarity (NPN/PNP) is configurable via the configuration tool.
- *7. An ethernet cable with an M12, 4-pin connector is required.

Connection

Basic connection with single OS32C unit Category 3, Performance Level d (ISO13849-1)

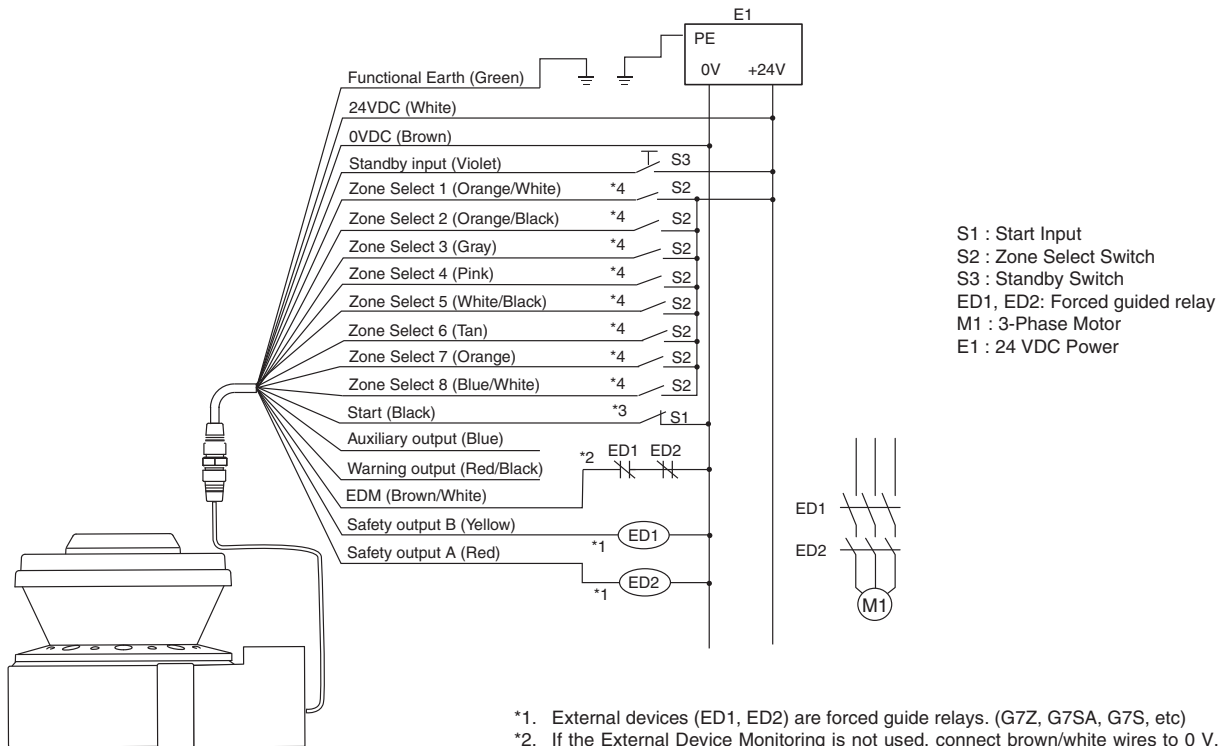

OS32C Configuration
 - External Device Monitoring Enabled
 - Start/Restart Interlock

- *1. External devices (ED1, ED2) are forced guide relays. (G7Z, G7SA, G7S, etc)
 - *2. If the External Device Monitoring is not used, connect brown/white wires to 0 V, and then turn OFF the External Device Monitoring with the configuration software.
 - *3. Use NC-contact for a start input.
 - *4. For zone select switch setting, refer to OS32C Series User's Manual.
- Note: This wiring example is for category 3.

Connecting to the Controller G9SA-301
 Category 3, Performance Level d (ISO13849-1)

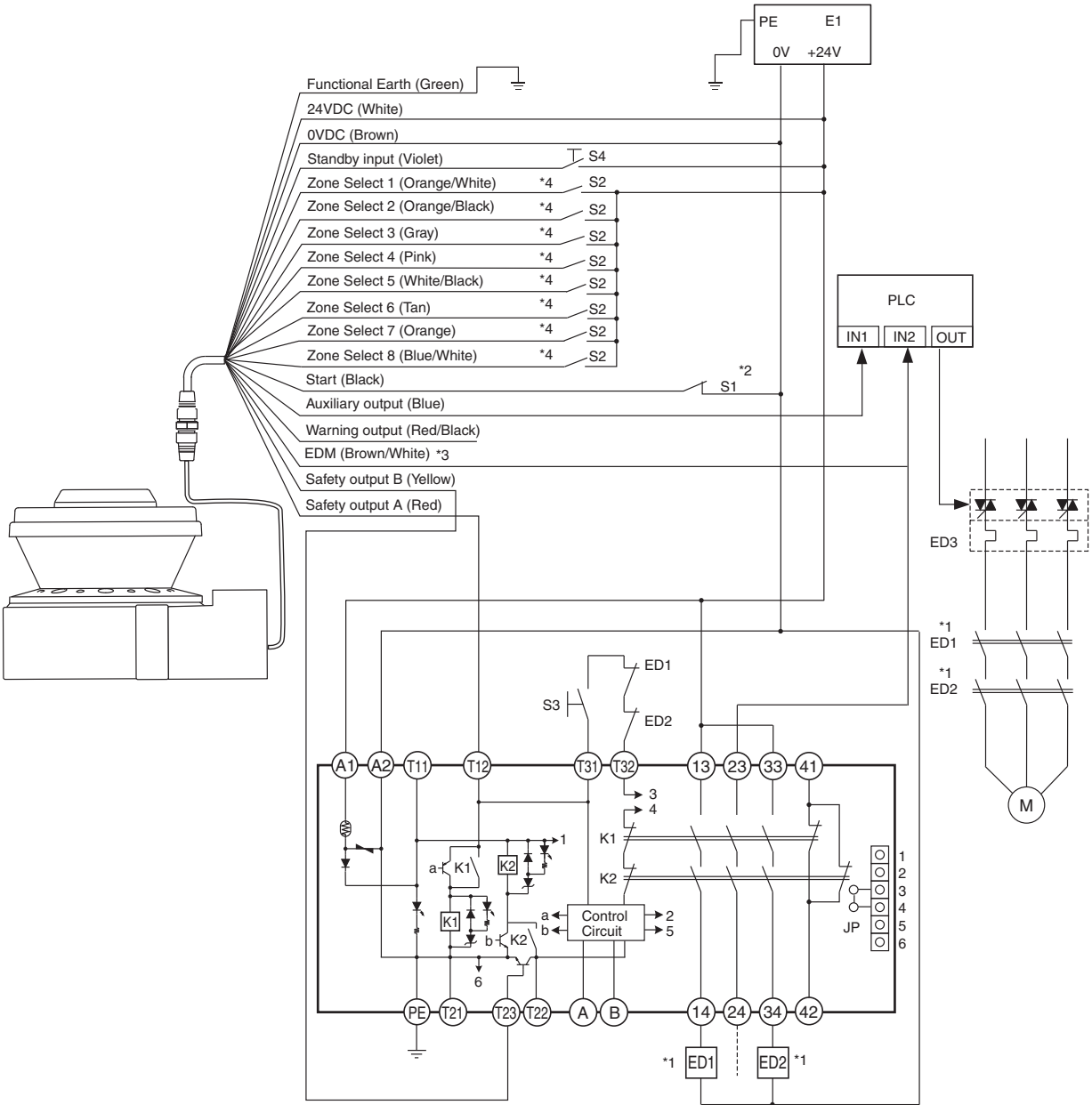

ED1, ED2: Forced guided relay
 ED3: Solid state contactor (G3J)
 M : 3-Phase Motor
 S1 : Start Input
 (use for releasing lockout)
 S2 : Zone Select Switch
 S3 : Reset Switch
 S4 : Standby Switch
 E1 : 24 VDC Power
 PLC: Programmable Controller
 (This is for monitoring only and
 unrelated to a safety system)

*1. External devices (ED1, ED2) are forced guide relays. (G7Z, G7SA, G7S, etc)
 *2. Use NC-contact for a start input.
 *3. If the External Device Monitoring is not used, connect brown/white wires to 0V, and then turn OFF the External Device Monitoring with the configuration software.
 *4. For zone select switch setting, refer to OS32C Series User's Manual.
 Note: This wiring example is for category 3.

Dimensions

OS32C with Back Location Cable Entry - OS32C-BP/OS32C-BP-DM

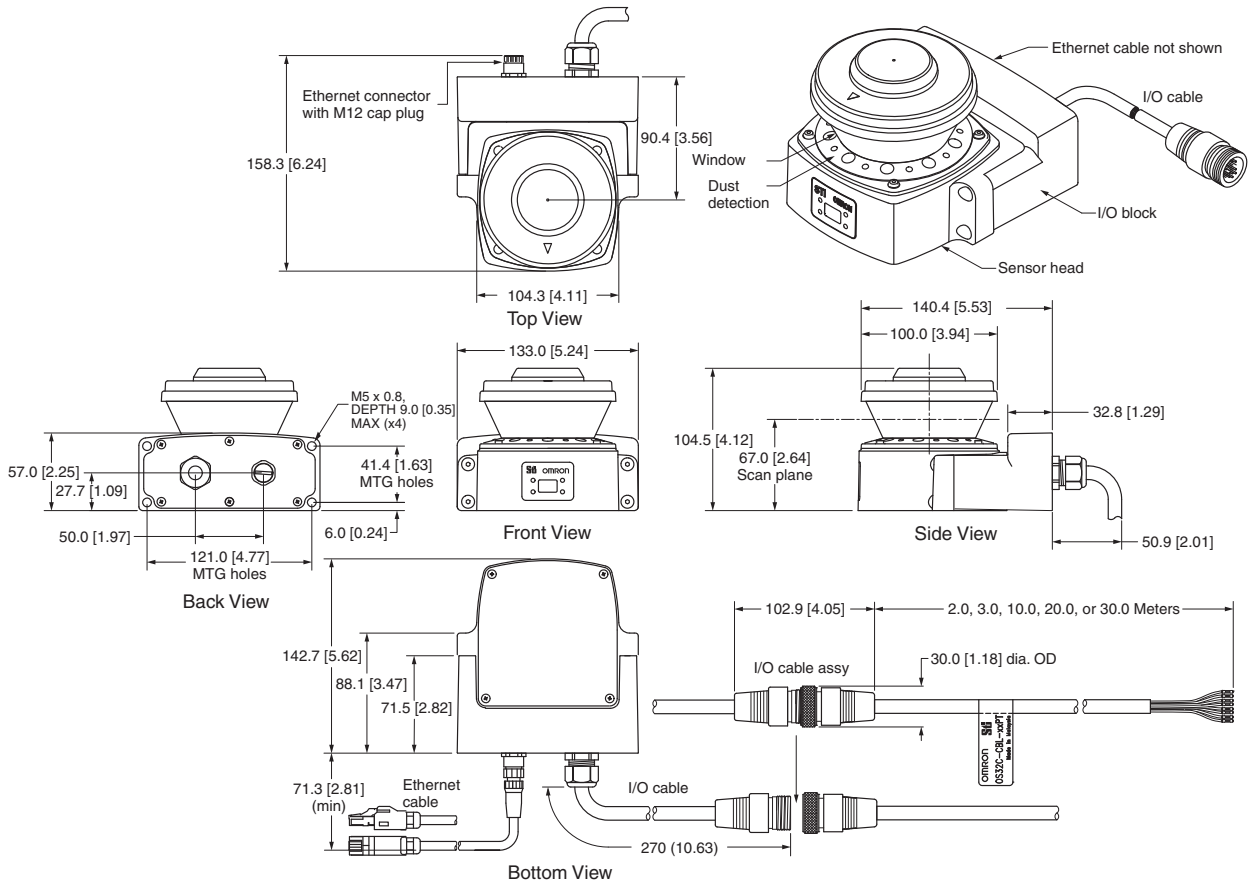

OS32C with Side Location Cable Entry - OS32C-SP1/OS32C-SP1-DM

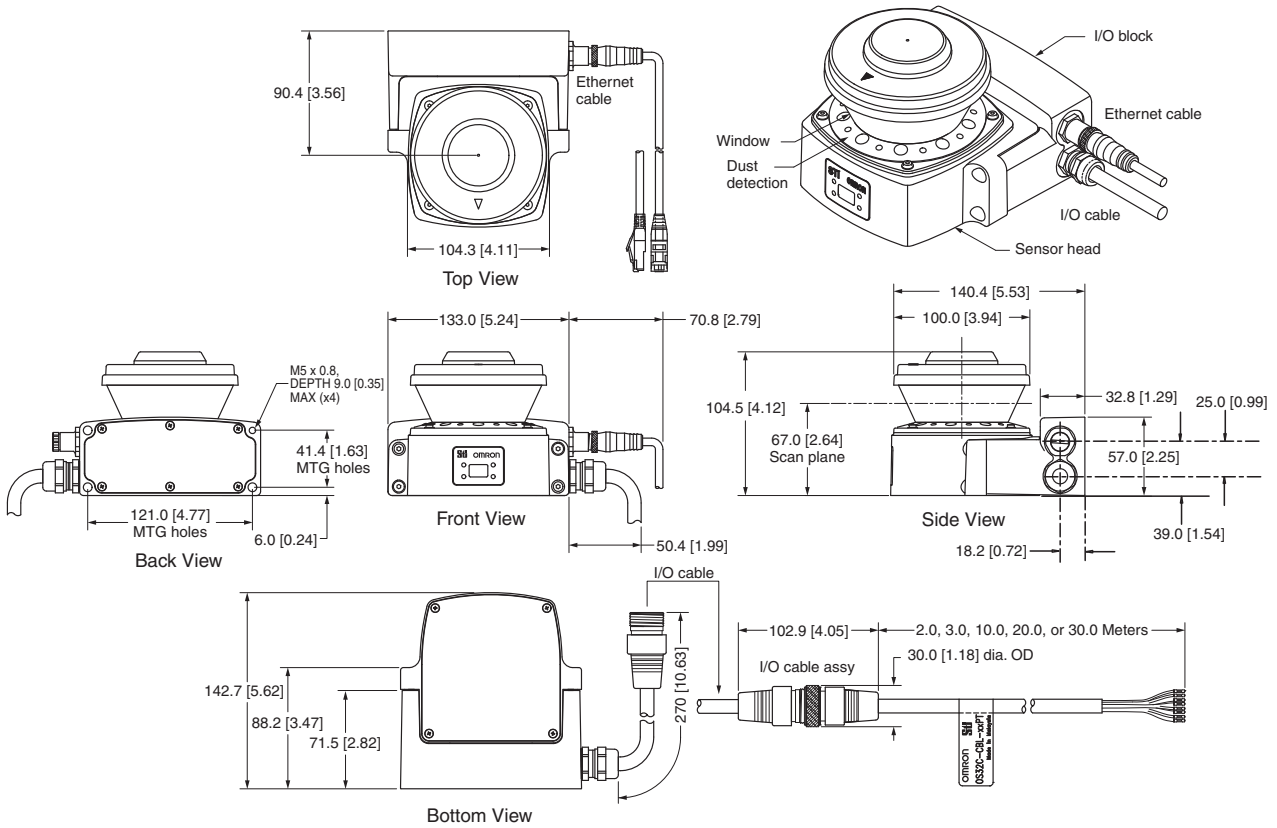

Firmware and Configuration Tool Features and Compatibility

Refer to the table below for supported features and compatibility with OS32C versions. Refer to the product labels to determine the OS32C version.

Note: • Only the version of the sensor block and the configuration tool were updated to support the new features. No changes were made to the I/O block.
 • The window replacement kit OS32C-WIN-KT can be used on any sensor block.



The part numbers have changed:

OS32C-SN: 40591-0010 (old), 40591-0020 (current)

OS32C-SN-DM: 40591-0040 (current)

OS32C-SN-4M: 40603-0020 (current)

OS32C-SN-DM-4M: 40603-0040 (current)

	OS32C Version		OS32C-DM	OS32C-4M	OS32C-DM-4M
	40591-0010	40591-0020	40591-0040	40603-0020	40603-0040
Configurable minimum object resolution	–	Supported	Supported	Supported	Supported
Standby mode with laser shutoff	–	Supported	Supported	Supported	Supported
Copy & paste zones and zone sets	–	Supported	Supported	Supported	Supported
Record system monitoring	–	Supported	Supported	Supported	Supported
Playback system monitoring	–	Supported	Supported	Supported	Supported
Support for inverting 7-segment display	–	Supported	Supported	Supported	Supported
Display configuration filename in config tool header	–	Supported	Supported	Supported	Supported
Additional zone shapes (180° semi-circle, 180° rectangle, 180° polygon)	–	Supported	Supported	Supported	Supported
Config tool support for switching between default OS32C configuration and the user's current working configuration	–	Supported	Supported	Supported	Supported
Troubleshooting tips displayed in fault log	–	Supported	Supported	Supported	Supported
Configuration checksum, safety checksum	Supported ^{*1}	Supported ^{*1}	Supported ^{*1}	Supported ^{*1}	Supported ^{*1}
Windows 7 support	–	Supported	Supported	Supported	Supported
Non-safety checksum	Supported ^{*2}	Supported ^{*2}	Supported ^{*2}	Supported ^{*2}	Supported ^{*2}
Single Import & Export Zone Coordinate Data	Supported ^{*2}	Supported ^{*2}	Supported ^{*2}	Supported ^{*2}	Supported ^{*2}
Maintenance access level	–	Supported ^{*3}	Supported ^{*2}	Supported ^{*2}	Supported ^{*2}
Rotation of monitor screen view	Supported ^{*4}	Supported ^{*4}	Supported ^{*4}	Supported ^{*4}	Supported ^{*4}
French, German, Italian & Spanish Languages	Supported ^{*4}	Supported ^{*4}	Supported ^{*4}	Supported ^{*4}	Supported ^{*4}
Multiple Import & Export Zone Coordinate Data	Supported ^{*4}	Supported ^{*4}	Supported ^{*4}	Supported ^{*4}	Supported ^{*4}
EtherNet/IP and Measurement Data	–	–	Supported	–	Supported
Pollution Tolerance Mode	–	Supported ^{*5}	Supported ^{*5}	Supported ^{*6}	Supported ^{*6}
Variable response time settings	–	Supported ^{*5}	Supported ^{*5}	Supported ^{*6}	Supported ^{*6}
4 meter safety/ 15 meter warning zone	–	–	–	Supported ^{*6}	Supported ^{*6}
Status information during monitor mode	–	Supported ^{*5}	Supported ^{*5}	Supported ^{*6}	Supported ^{*6}
Global Confirmation of Safety parameters	–	Supported ^{*5}	Supported ^{*5}	Supported ^{*6}	Supported ^{*6}
EtherNet/IP Warning zone change capable	–	–	Supported ^{*5}	–	Supported ^{*6}

*1. Requires Configuration Tool Version 1.4.0 and up

*2. Requires Configuration Tool Version 1.6.0 and up

*3. If serial number of the sensor block is higher than AS08300 and Configuration Tool is version 1.6.0 and up

*4. Requires Configuration Tool is Version 1.8.0 and up

*5. If serial number of the sensor block is higher than AS15500 and Configuration Tool is Version 2.0.0 and up

*6. Requires Configuration Tool is Version 2.0.0 and up

	Configuration Tool Version				
	before 1.4.0	1.4.0 and up	1.6.0 and up	1.8.0 and up	2.0.0 and up
Configurable minimum object resolution	–	Supported	Supported	Supported	Supported
Standby mode with laser shutoff	–	Supported	Supported	Supported	Supported
Copy & paste zones and zone sets	–	Supported	Supported	Supported	Supported
Record system monitoring	–	Supported	Supported	Supported	Supported
Playback system monitoring	–	Supported	Supported	Supported	Supported
Support for inverting 7-segment display	–	Supported	Supported	Supported	Supported
Display configuration filename in config tool header	–	Supported	Supported	Supported	Supported
Additional zone shapes (180° semi-circle, 180° rectangle, 180° polygon)	–	Supported	Supported	Supported	Supported
Config tool support for switching between default OS32C configuration and the user's current working configuration	–	Supported	Supported	Supported	Supported
Troubleshooting tips displayed in fault log	–	Supported	Supported	Supported	Supported
Configuration checksum, safety checksum	–	Supported	Supported	Supported	Supported
Windows 7 support	–	Supported	Supported	Supported	Supported
Non-safety checksum	–	–	Supported	Supported	Supported
Single Import & Export Zone Coordinate Data	–	–	Supported	Supported	Supported
Maintenance access level	–	–	Supported	Supported	Supported
Rotation of monitor screen view	–	–	–	Supported	Supported
French, German, Italian & Spanish Languages	–	–	–	Supported	Supported
Multiple Import & Export Zones Coordinate Data	–	–	–	Supported	Supported
Pollution Tolerance Modes	–	–	–	–	Supported
Variable response time settings	–	–	–	–	Supported
4 meter safety/ 15 meter warning zone	–	–	–	–	Supported
Status information during monitor mode	–	–	–	–	Supported
Global Confirmation of Safety parameters	–	–	–	–	Supported
EtherNet/IP Warning zone change capable	–	–	–	–	Supported

Model	Sensor Head P/N	Configuration Tool Version				
		before 1.4.0	1.4.0 and up	1.6.0 and up	1.8.0 and up	2.0.0 and up
OS32C-SN	40591-0010	Supported	Supported	Supported	Supported	Supported
OS32C-SN	40591-0020	–	Supported	Supported	Supported	Supported
OS32C-SN-DM	40591-0040	–	–	Supported	Supported	Supported
OS32C-SN-4M	40603-0020	–	–	–	–	Supported
OS32C-SN-DM-4M	40603-0040	–	–	–	–	Supported

Cat. No. Z298-E2-05-X

In the interest of product improvement, specifications are subject to change without notice.

OMRON EUROPE B.V.

Wegalaan 67-69,
 NL-2132 JD, Hoofddorp,
 The Netherlands
 Phone: +31 23 568 13 00
 Fax: +31 23 568 13 88
 industrial.omron.eu